

花蓮縣宜昌國中 111 學年度第一學期第一次段考七年級英語科試題卷

命題教師：徐美雲

範圍：Book 1 L 1 ~ L 2

考試時間：60 分鐘

班級 Class：_____ 座號 Number：_____ 姓名 Name：_____

1. 本試題卷有三大部分總共六頁，請注意題號並記得換頁作答。
2. 1- 38 題為單題選擇題，請以 2B 鉛筆將各題最適合的答案代碼劃在答案卡上。
3. 第三部分為紙筆測驗，請務必使用黑色原子筆在答案卷上作答。
4. 本次段考成績為紙筆測驗 90 分，口試 10 分，共 100 分。

第一部分：聽力測驗 (1~10 題，每題 2 分；11~14 題，每題 1 分。共 24 分)

本測驗共有三大題，每一小題都會唸兩次，請同學們注意聽 CD，仔細作答。

Part 1 辨識句意：第 1 題~第 5 題，每題有三張圖片，請依據所聽到的內容，選出符合描述的圖片。

01.	(A) 	(B) 	(C) 
02.	(A) 	(B) 	(C) 
03.	(A) 	(B) 	(C) 
04.	(A) 	(B) 	(C) 
05.	(A) 	(B) 	(C) 

請翻頁繼續作答

Part 2 基本問答：第 6 題～第 10 題，每題均有三個選項，請依據所聽到的內容，選出一個最適當的回應。

6. (A) Thank you.
(B) Yes, it's my car.
(C) You're welcome.
7. (A) I'm a farmer.
(B) I'm in your family.
(C) I'm Vincent, Tina's friend.
8. (A) He's young.
(B) He's my husband.
(C) Yes, he's tall.
9. (A) What size are you?
(B) Yes, they are the right size.
(C) These shoes aren't the same.
10. (A) His birth year is 1989.
(B) Yes. He is nice and warm.
(C) No, his animal sign is a goat.

Part 3 言談理解：第 11 題～第 14 題，每題均有三個選項，請依據所聽到的對話與問題，選出一個最適當的答案。

11. (A) Mr. Li is thin and short.
(B) Anna Snow is a PE teacher.
(C) The new math teacher isn't from Taiwan.
12. (A) She's Bruce's new doctor.
(B) She's the man's new doctor.
(C) She's the doctor's daughter.
13. (A) A rat.
(B) A snake.
(C) A goat.
14. (A) The woman's mice are in the box.
(B) The toys are for the woman's pets.
(C) The birthday gifts for the man are in the box.

【聽力測驗結束】

第二部份：綜合測驗（共 48 分）

一、單題（第 15~24 題，每題 2 分，共 20 分）：下列各題請依據題意選出一個最正確或最佳的答案。

() 15. Look at the _____. Let's not drink on the bus.

- (A) size
(B) sign
(C) warm person
(D) movie theater

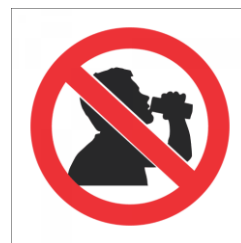

() 16. Joann is smart, _____ she isn't nice to her family.

- (A) but (B) and (C) too (D) like

() 17. Jeff's pet rooster is _____. No wonder he is sad.

- (A) young (B) true (C) same (D) dead

() 18. Vivian: Are you _____ eye doctor?

John: No, I'm _____ teacher.

- (A) an ; an (B) a ; an (C) a ; a (D) an ; a

請翻頁繼續作答

- () 19. Kevin: Is that your picture?
Judy: No, _____ my brother's picture.
(A) it (B) it's (C) they (D) they're
- () 20. Gary: Those _____ are not my friends. They are my parents.
Lily: Wow, they are young. Your mother is beautiful.
(A) man (B) woman (C) person (D) people
- () 21. Sally: What are _____?
Anna: They are my erasers.
(A) this (B) that (C) these (D) it
- () 22. Linda: What is Peter's animal sign?
Mr. Brown: He is a snake. _____
Linda: I am a monkey.
(A) What about you? (B) How old are you?
(C) Are you like a monkey? (D) Who are you?
- () 23. Scott: Your watch is green. My watch is blue.
Ms. Hsu: _____ watches are not the same.
(A) We (B) Our (C) They (D) Their
- () 24. Jimmy: Sam is nice to Paul. Aren't they like brothers?
Eric: _____
(A) Yes, we are. (B) No, we are not brothers.
(C) Yes, they are. (D) No, they are like brothers.

二、題組 (第 25~38 題, 每題 2 分, 共 28 分)

1. (25 - 28) 請選出正確的對話內容。

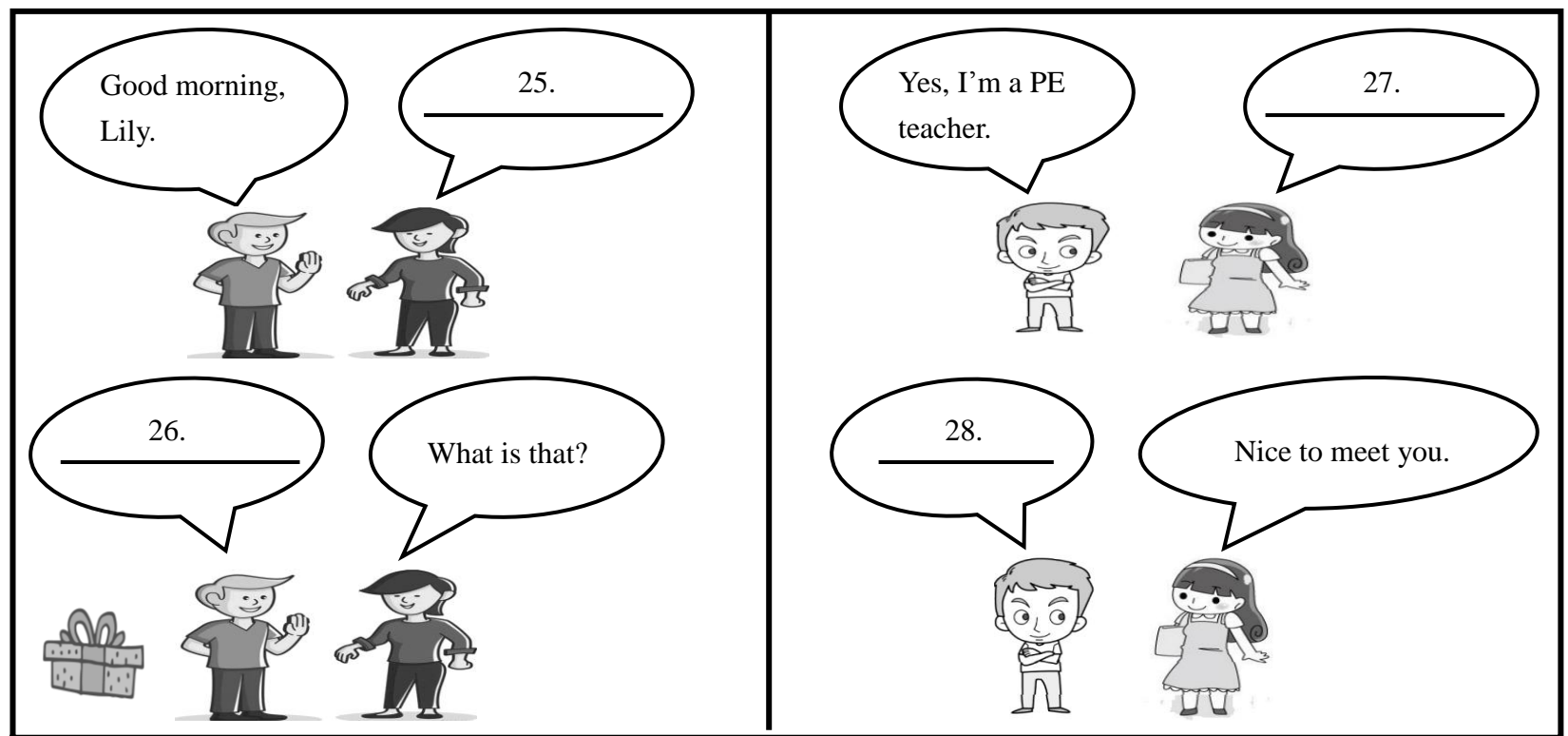

- () 25. (A) Thank you, Jack.
(C) You are a people person, Jack.
(B) Goodbye, Jack.
(D) Good morning, Jack.
- () 26. (A) Yes, that is my doll.
(C) No, that is your key.
(B) The robot is great.
(D) It's a gift for my daughter.
- () 27. (A) What is this?
(C) Is he a PE teacher?
(B) Are you a teacher?
(D) Who is this young man?
- () 28. (A) Are you a student?
(C) Nice to meet you, too.
(B) What's your animal sign?
(D) You are a nice child, too.

2. (29 ~ 31)

Hello, I am Kevin. I am a junior high school student. My mother is a cook. She likes to listen to music. My father is a farmer. He is an energetic man. 29. are nice. I have two brothers and a sister. Jack is my brother. He is a nurse. Bob is my brother, 30. He is a senior high school student. Lily is my sister. She is a doctor. She likes to play with our pet fox. Lulu is a cute fox. She is 31. We are a happy family.



- () 29. (A) Those (B) These (C) They (D) That
 () 30. (A) too (B) here (C) now (D) like
 () 31. (A) three-year-old (B) three years old (C) three years (D) a three-year-old

3. (32 ~ 34)

MISSING

Lucky
 one year old
 short black hair
 long ears and short legs
 He likes to run.



If you see him, please call 8520803 Ann

Kiki
 six years old
 short orange hair
 big eyes and small ears
 She is beautiful.



If you see her, please call 0999111991 Mr. Lin

Bunny
 four years old
 long white hair
 long ears and red eyes
 She likes to jump.



If you see her, please call 8539172 Nick

Mickey
 two years old
 black and white hair
 big ears and a small mouth
 He is cute.



If you see him, please call 0998555111 Ms. Chen

if 如果；call 打(電話)

- () 32. What is right?
 (A) Lucky likes to run. He is an old dog.
 (B) Bunny has long red hair. She likes to jump.
 (C) Mr. Lin has a beautiful mouse. Her ears are small.
 (D) Mickey's mouth is small. His color is black and white.

() 33. What animal is ?

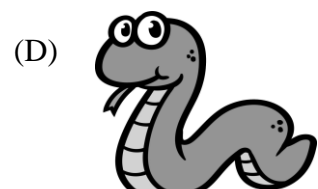

- () 34. If you see Kiki, please call _____ .
 (A) Ann
 (B) Nick
 (C) Ms. Chen
 (D) Mr. Lin

請翻頁繼續作答

4. (35~38)

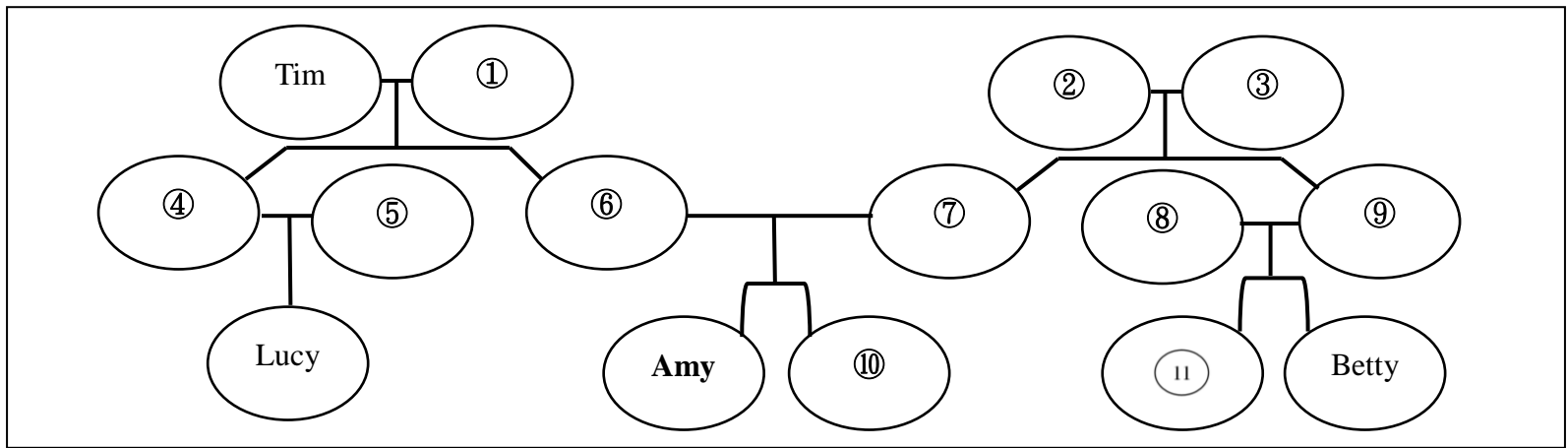

Please read the sentences and help Amy finish her family tree.

📖 sentence 句子 ; finish 完成

- Sam is Amy's brother.
- Tony is Sam's father.
- Tim's wife is Anna.
- Mary is Amy's mother.
- Tony's parents are Mike and Jane.
- Peter is Mary's brother.
- Cindy's husband is Peter.
- David and Tony are brothers.
- Scott is David and Helen's son.

- () 35. Amy and Betty are _____ .
 (A) sisters (B) parents (C) friends (D) cousins
- () 36. Who is Tony?
 (A) ④ (B) ⑥ (C) ⑦ (D) ⑨
- () 37. Who is **not** Lucy's cousin?
 (A) Amy (B) Scott (C) Betty (D) Tim

- () 38. Which is **true**? 📖 which 哪一個
 (A) Peter and David are Amy's uncles. (B) Helen is Betty's grandmother.
 (C) Cindy and Peter are Scott's parents. (D) Mike is Anna and Sam's father.

請翻頁繼續作答

第三部分：寫作測驗（共 18 分；請務必使用黑色原子筆做答，否則將不予計分）

一、寫出下列單字的小寫(每題 1 分，共 4 分) Class 班級: No. 座號: Name 姓名:

1. CAT	2. DOG	3. FIVE	4. PENCIL
<input type="text"/> <input type="text"/> <input type="text"/>	<input type="text"/> <input type="text"/> <input type="text"/>	<input type="text"/> <input type="text"/> <input type="text"/>	<input type="text"/> <input type="text"/> <input type="text"/>

二、依圖示作答（每格 1 分，共 10 分）

請將正確答案寫在右邊空格中，以便完成家族樹圖。
下列為參考字詞。

sister
uncle
aunt
father
mother
cousin
brother
grandfather
grandmother

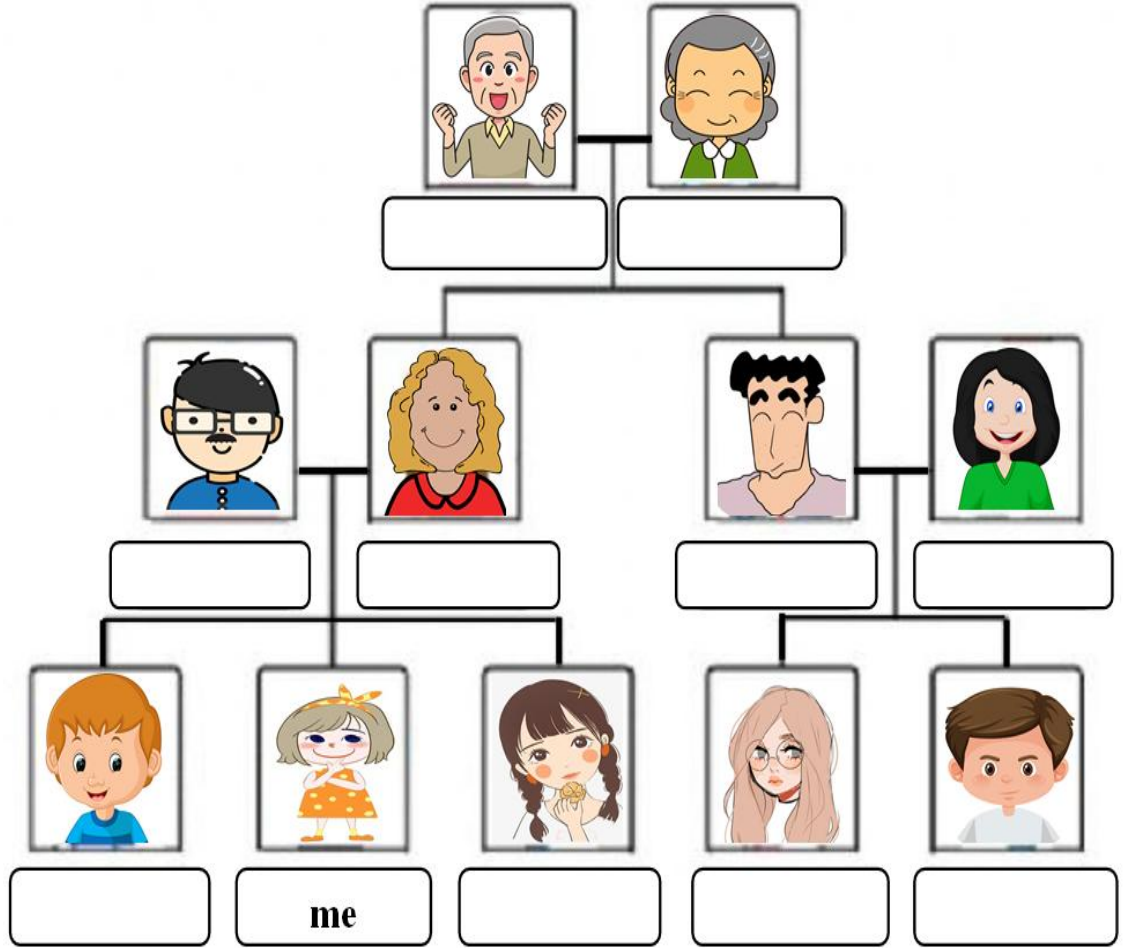

三、依提示作答（每題 2 分，共 4 分）

1. Sally: _____ (請造原問句)

Mr. Lin: The tall and thin woman is my wife.

2. Abby: Are these your pet sheep? (請根據右邊圖示先簡答，再詳答)

Ken: _____

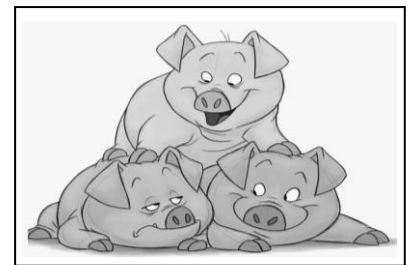

3. 加分題: How many animals can you see?

請將答案寫在下方空格中。(每個單字 1 分，最多 5 分)



1. _____	2. _____
3. _____	4. _____
5. _____	

試題結束

記得仔細檢查，並將 **答案卡** 繳回，同時請記得繳交 **手寫卷**

花蓮縣宜昌國中 111 學年度第一學期第一次段考七年級英語科答案

選擇題:1~10 題, 每題 2 分; 11~14 題, 每題 1 分; 15~38 題, 每題 2 分, 共 72 分

1-5	C	B	A	A	C
6-10	A	C	B	A	B
11-15	B	C	C	B	B
16-20	A	D	D	B	D
21-25	C	A	B	C	D
26-30	D	B	C	C	A
31-35	B	D	A	D	D
36-38	C	D	A		

A:9 B:10 C:10 D:9

手寫題:共 18 分

一、寫出下列單字的小寫(每題 1 分, 共 4 分)

1. CAT <div style="border: 1px solid black; padding: 2px; display: inline-block;">cat</div>	2. DOG <div style="border: 1px solid black; padding: 2px; display: inline-block;">dog</div>	3. FIVE <div style="border: 1px solid black; padding: 2px; display: inline-block;">five</div>	4. PENCIL <div style="border: 1px solid black; padding: 2px; display: inline-block;">pencil</div>
--	--	--	--

二、依圖示作答(每格 1 分, 共 10 分)

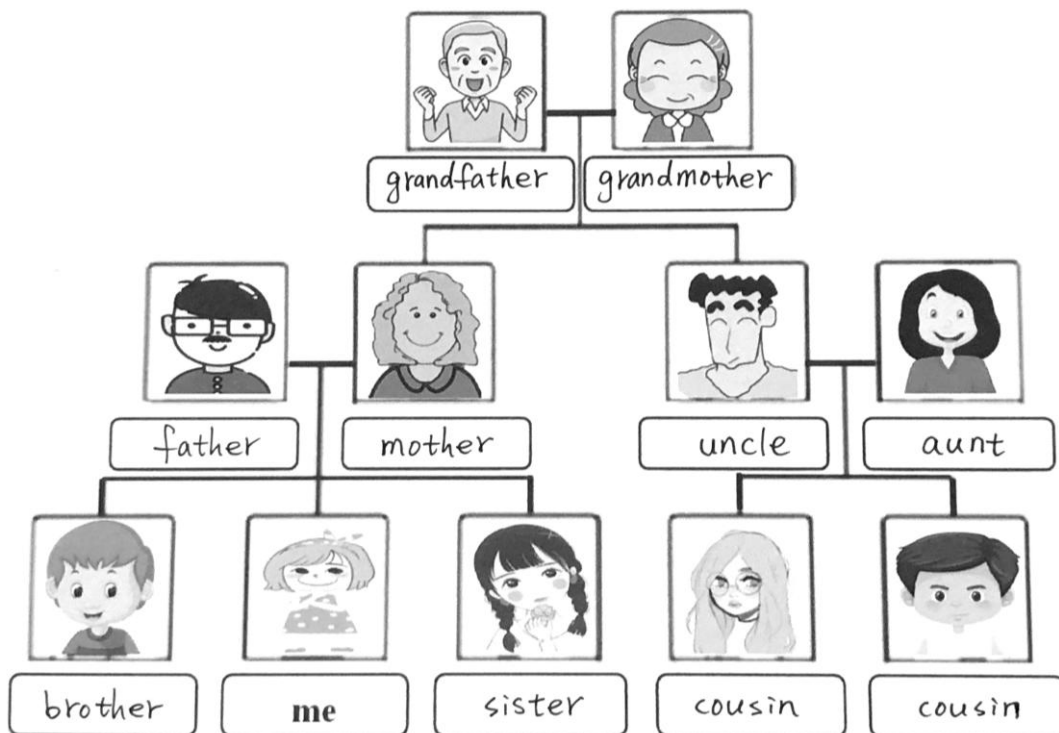

三、依提示作答(每題 2 分, 分段給分, 共 4 分)

1. Sally: Who's / that tall and thin woman? ; Who's / that woman? ; Who's / she? (請造原問句)

Mr. Lin: The tall and thin woman is my wife.

2. Abby: Are these your pet sheep? (請根據右邊圖示先簡答, 再詳答)

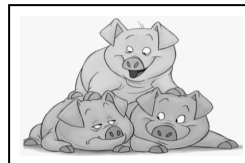

Ken: No, they aren't. / They are my pet pigs.

3. 加分題: How many animals can you see?

請將答案寫在下方空格中。(每個單字 1 分, 最多 5 分)



1. a bear 2. a bird 3. a cat 4. a fish 5. a dog
(參考答案)

第一部分：聽力測驗

※聽力測驗 CD 只播放一次，每題唸兩次。本測驗共有三大題，每一題均為單選題。

Part 1 辨識句意：

作答說明：每題均有三張圖片，請依據所聽到的句子，選出符合描述的圖片，每題播放兩次。聽力測驗開始。

1. Mrs. Lin is Bill's aunt, and she is our teacher. She's nice to us.
2. My uncle and I like this nice park. It's beautiful.
3. My sister, Anna, is in the kitchen now. She's cooking lunch.
4. M: What are those animals? Are they dogs?
W: No, they are tigers.
5. The pictures on the T-shirts are not the same. This is a tiger, and that is a bear.

Part 2 基本問答：

作答說明：每題均有三個選項，請依據所聽到的內容，選出一個最適合的回應，每題播放兩次。聽力測驗開始。

6. Your car is beautiful.
7. (M:) Hi, I'm Joe, Tina's cousin. And you are...?
8. Who is that tall man?
9. These shoes aren't my size.
10. Mr. White is a people person. Is that true?

Part 3 言談理解：

作答說明：每題均有三個選項，請依據所聽到的對話或短文內容，選出一個最適合的答案，每題播放兩次。聽力測驗開始。

11. M: Is the short woman our new math teacher?
W: No, she's a PE teacher, and her name is Anna Snow. Mr. Li is the new math teacher.
M: Mr. Li? The tall man from Taiwan?
W: That's right.
Q: What is right?
12. M: Vicky, who is this Bruce Wang?
W: He's your new doctor, and he's my father, too.
M: Cool!
Q: Who is Vicky?
13. G: What's your naimal sign?
B: I'm a goat. What about you?
G: Same here.
B: You're thirteen years old, too. Right?
Q: What is the girl's animal sign? These shoes aren't my size.
14. M: Your mice are cute.
W: Thank you.
M: What are those in the blue box?
W: They're toys for my mice. Today is their birthday.
Q: What is right?